

# ophelis docks Bancs



# Caractéristiques du produit

- Différentes utilisations grâce aux multiples possibilités de combinaisons
- Ilôt au bureau : point de rencontre pour le travail en mode projet ou d'équipe ou les échanges informels
- Postes de travail temporaires
- Espaces salon ou d'accueil
- Électrification intégrée
- Piétement disponible en bois ou en aluminium
- Profondeur de 600 mm pour une utilisation optimale de l'espace au sol
- Deux hauteurs d'assise disponibles : 400 mm + 450 mm

# Dimensions

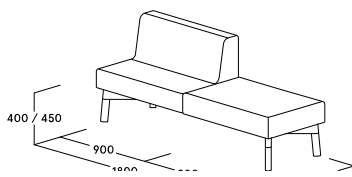
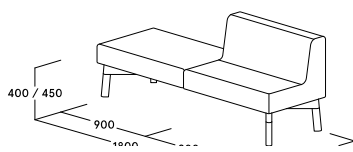
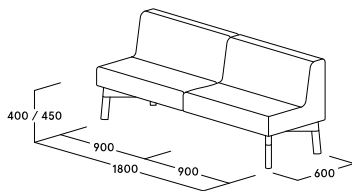
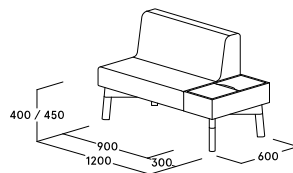
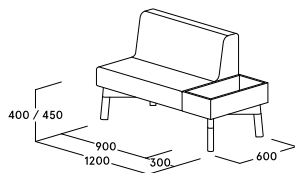
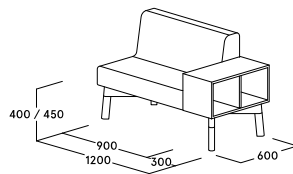
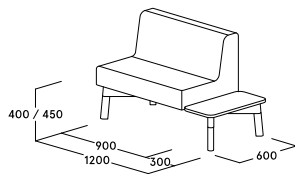
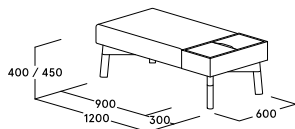
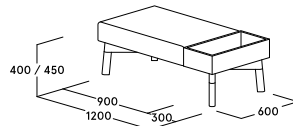
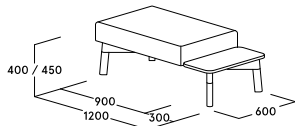
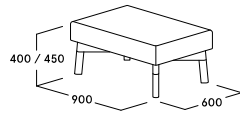
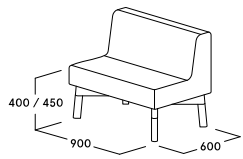

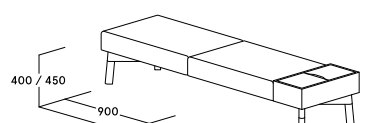
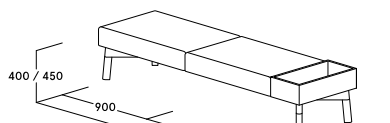
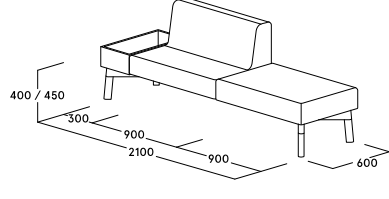
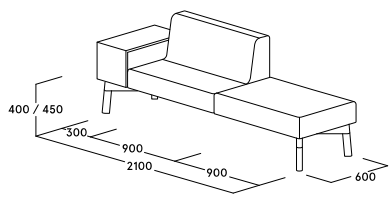
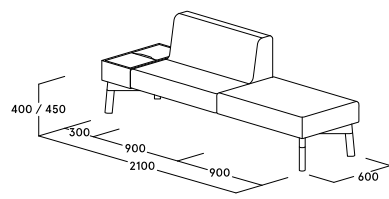
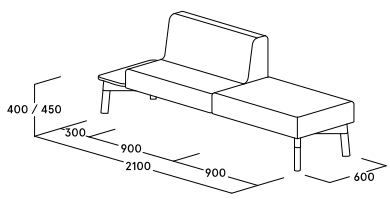
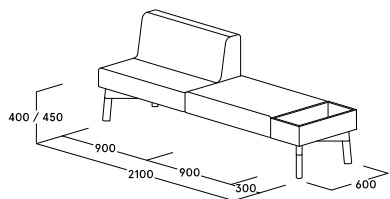
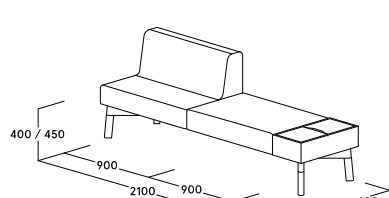
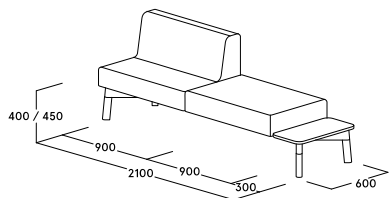
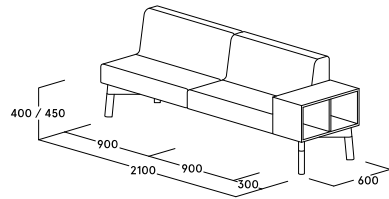
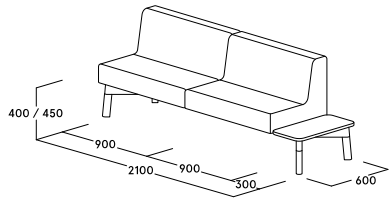
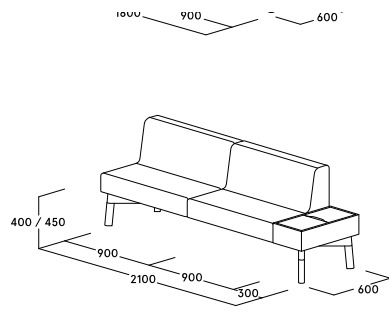
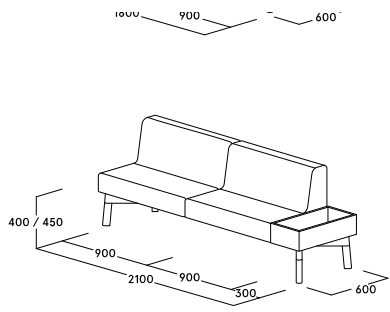

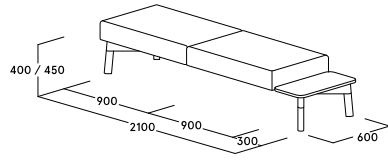
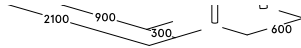

# Couleurs et matières

## Tissus: Kvadrat Remix 3 (PG 21)

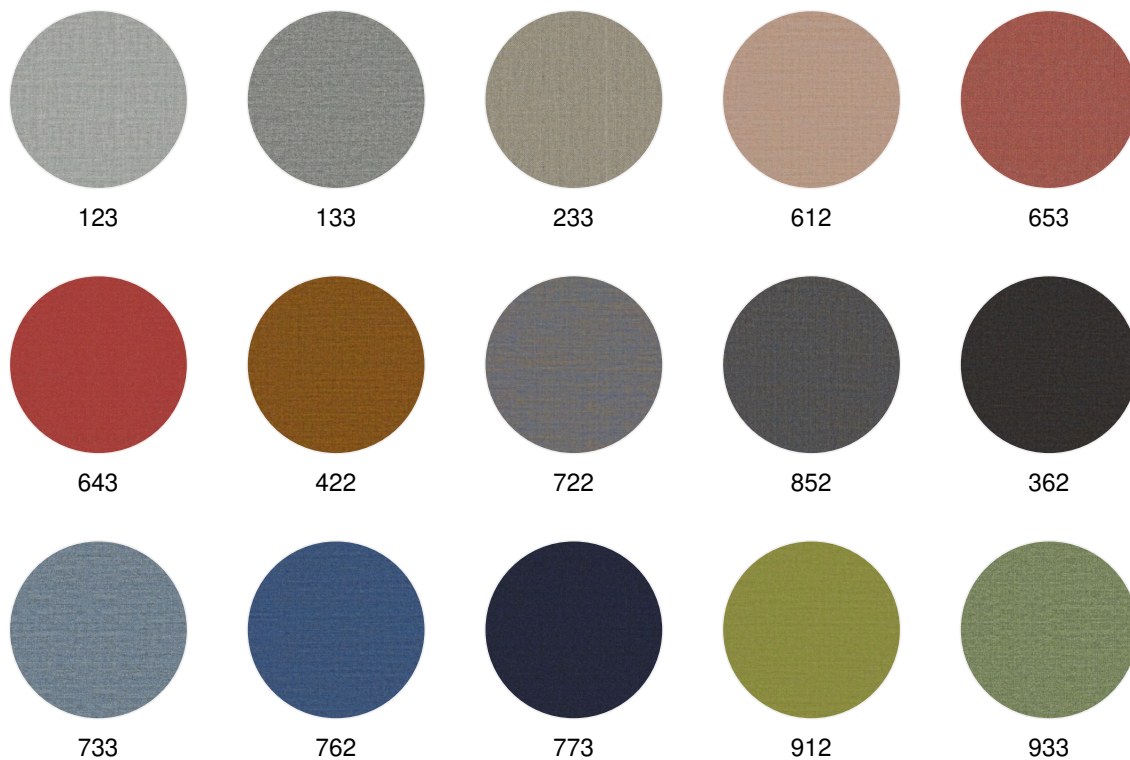

## Tissus: Kvadrat Atlas (PG 21)

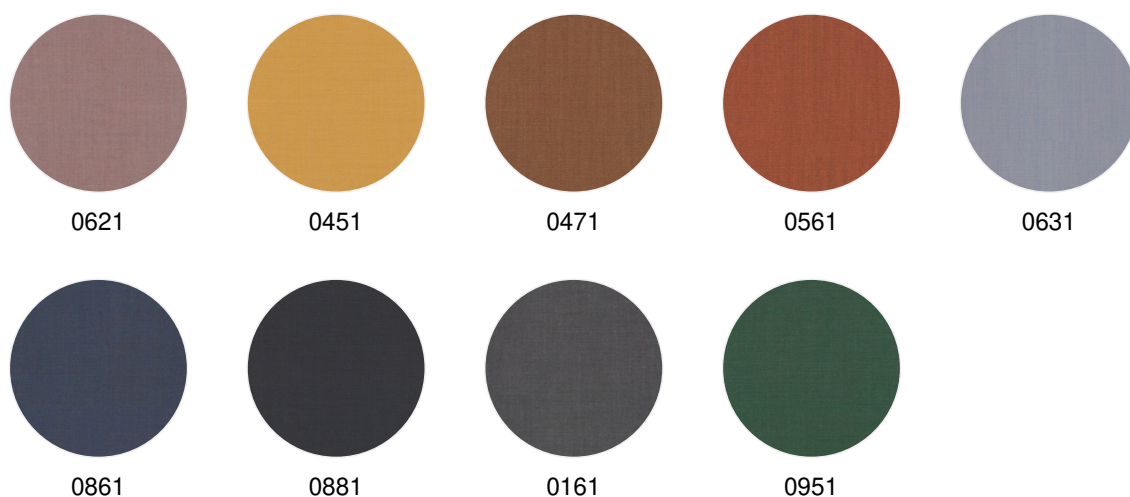

**Tissus: Kvadrat Steelcut Trio 3 (PG 22)**

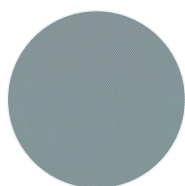

713

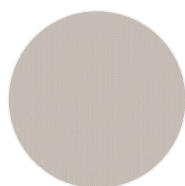

213

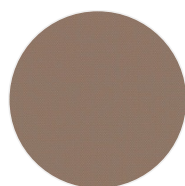

426

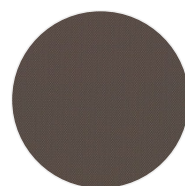

276

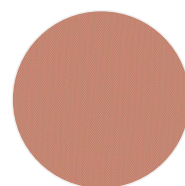

515

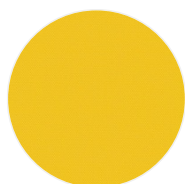

446

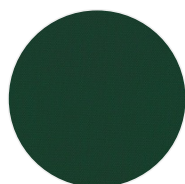

976

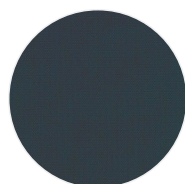

883

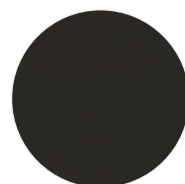

383

**Tissus: Kvadrat Fiord 2 (PG 22)**

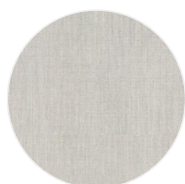

101

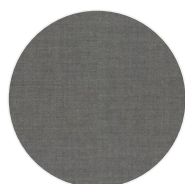

151

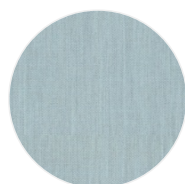

721

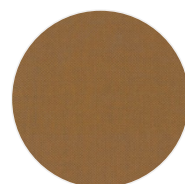

451

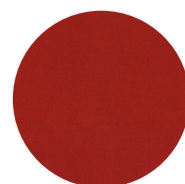

571

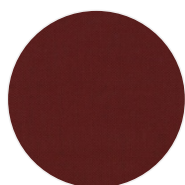

581

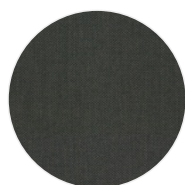

971

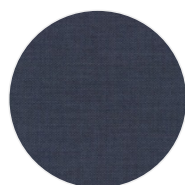

771

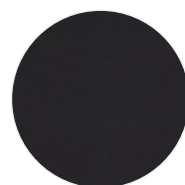

981

**Tissus: Kvadrat Field 2 (Tissu fonctionnel) (NF P 92 507 M1) (PG 22)**

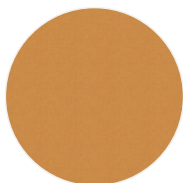

0463

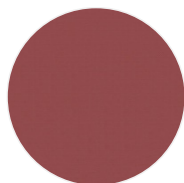

0643

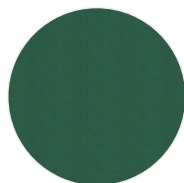

0963

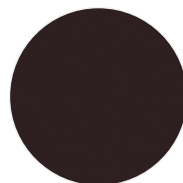

0693

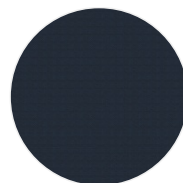

0782

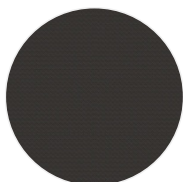

0182

**Tissus: Kvadrat Febrik Mosaic 2 (PG 23)**

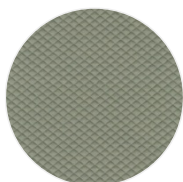

0922

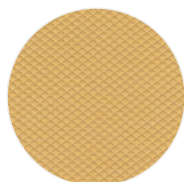

0422

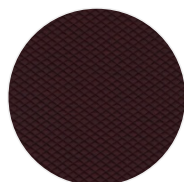

0682

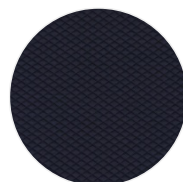

0692

**Tissus: Kvadrat Febrik Plecto (PG 23)**



0224

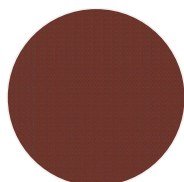

0564

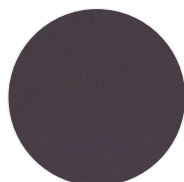

0654



0984



**Tissus: Kvadrat Hallingdal 65 (PG 23)**



0103

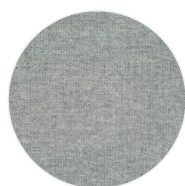

0116

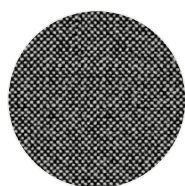

0166

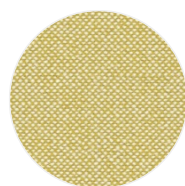

0407

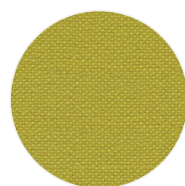

0420



0687



0764

**Tissus: Kvadrat Divina 3 (PG 23)**

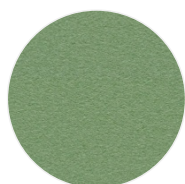

0856

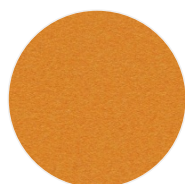

0444



0584

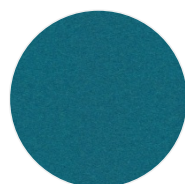

0893

**Tissus: Kvadrat Divina Melange 3 (PG 23)**

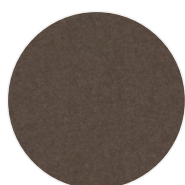

0260



0567



0747

**Tissus: Kvadrat Divina MD (PG 23)**

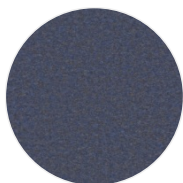

0753



0813

**Tissus: Kvadrat Coda 2 (PG 26)**



116



442



962



382

**Tissus: Camira Blazer (PG 21)**



CUZ2Q

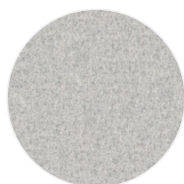

CUZ28

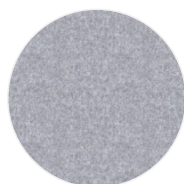

CUZ1E

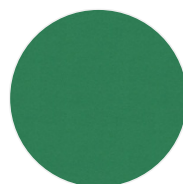

CUZ3A

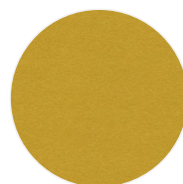

CUZ2W



CUZ21

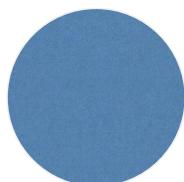

CUZ1V

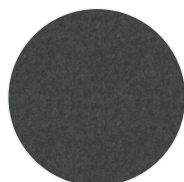

CUZ67

**Tissus: Camira Mainline Flax (PG 21)**

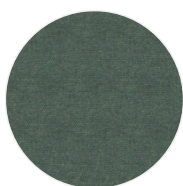

MLF32

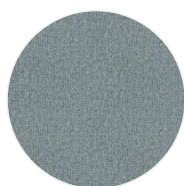

MLF22

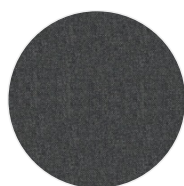

MLF16



MLF23

**Tissus: Camira Synergy (PG 21)**

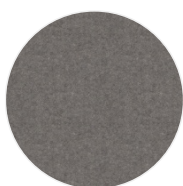

LDS35



LDS46

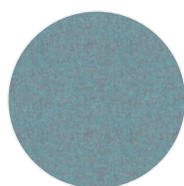

LDS56

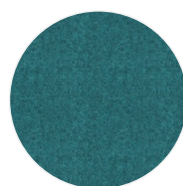

LDS59

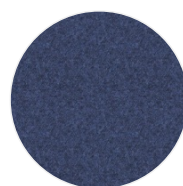

LDS62



LDS76



LDS77

**Tissus: Camira Vita (Tissu fonctionnel) (PG 21)**



ITA03



ITA11



ITA22

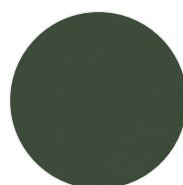

ITA29

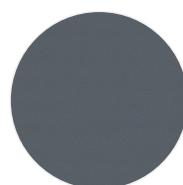

ITA04

## Cuir véritable: Muirhead Caledonian (PG 25)

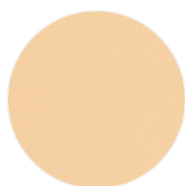

SX001



SX004



SX005



SX006

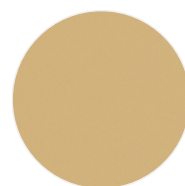

SX007



SX009

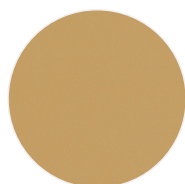

SX010



SX011

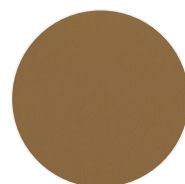

SX008

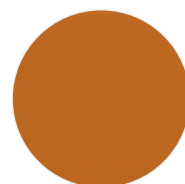

SX016



SX028

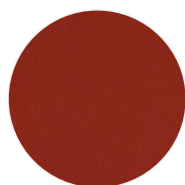

SX012



SX014



SX015



SX625



SX017



SX031

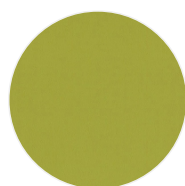

SX018

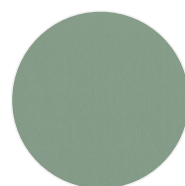

SX032

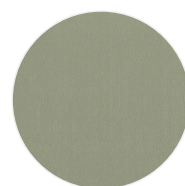

SX019

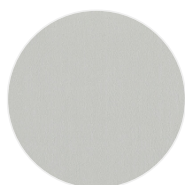

SX033

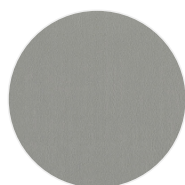

SX020

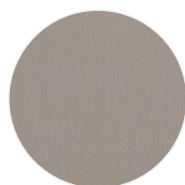

SX026

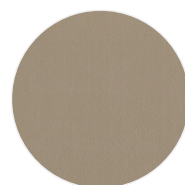

SX034

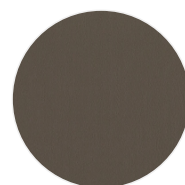

SX025



SX024



SX023



SX022



SX021



SX027

**Cuir véritable: Elmo Leather Elmosoft (PG 26)**



00100



05011



22030



00109

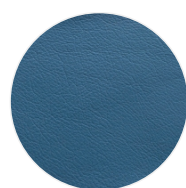

17027



55002



01037



01061



01003



11049



54035



13072



33001



33004



35126

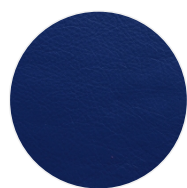

77158



93129



95006



93068



71017



77127



97038



98015



99999

## piètements



blanc lumière  
(RAL 9016)



Aluminium poli

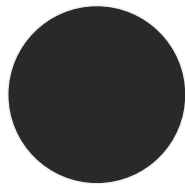

noir graphite  
(RAL 9011)



chêne naturel  
huilé

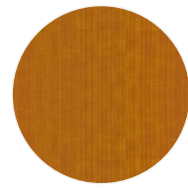

cerisier huilé



noyer huilé

## Revêtements: Bois véritable



érable naturel



érable huilé



chêne blanchi à  
la chaux



chêne blanchi à  
la chaux huilé



chêne naturel



chêne huilé



hêtre naturel



cerisier

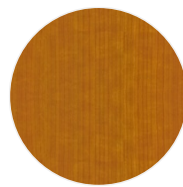

cerisier huilé



noyer



noyer huilé



chêne fumé



chêne noir

## Revêtements: Mélamine



blanc atlas



blanc crème



blanc soft



gris lumière

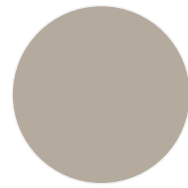

Gris soie

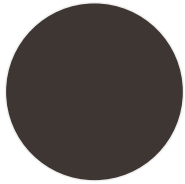

brun gris

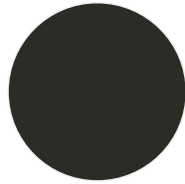

graphite

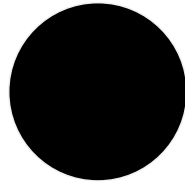

noir



imitation érable



chêne claire



hêtre claire

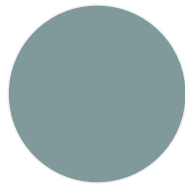

gris vert

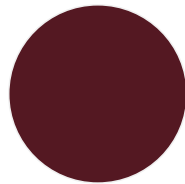

bordeaux

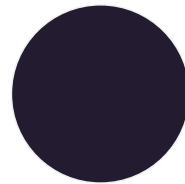

bleu noir

## Revêtements: laque



blanc  
signalisation  
(RAL 9016)



blanc crème  
(RAL 9001)

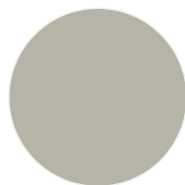

gris soie  
(RAL 7044)

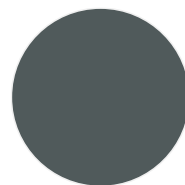

gris fer  
(RAL 7011)

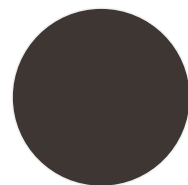

brun gris  
(RAL 8019)



vert pâle

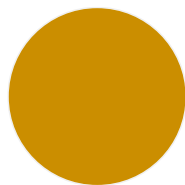

Jaune miel  
(RAL 1005)

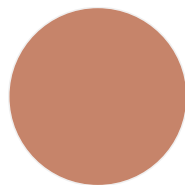

rouge beige  
(RAL 3012)

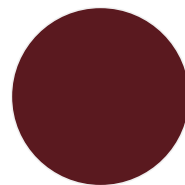

bordeaux  
(RAL 3005)

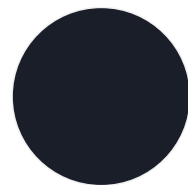

bleu noir  
(RAL 5004)





## Download données de planification

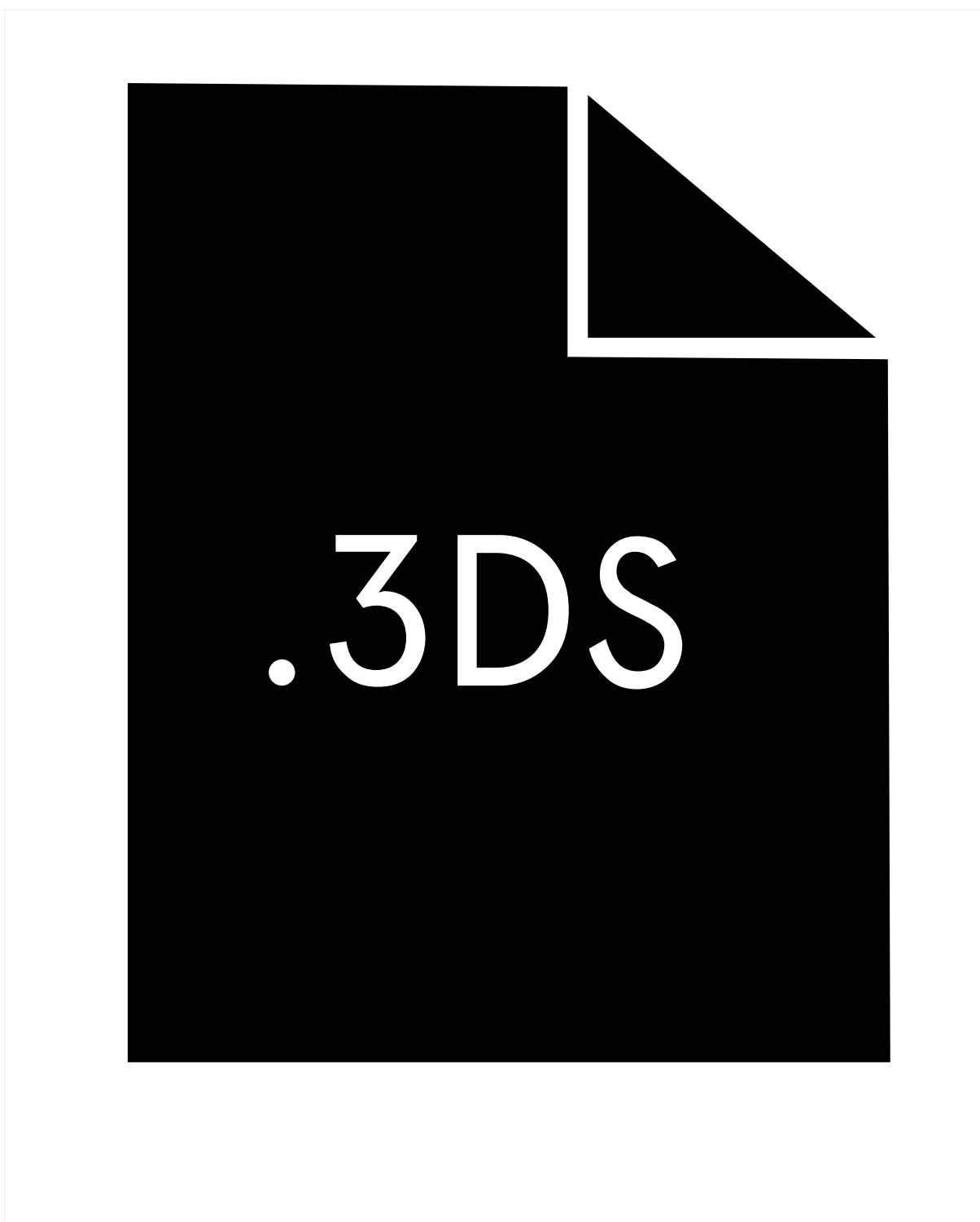

ophelis docks Bancs 3DS

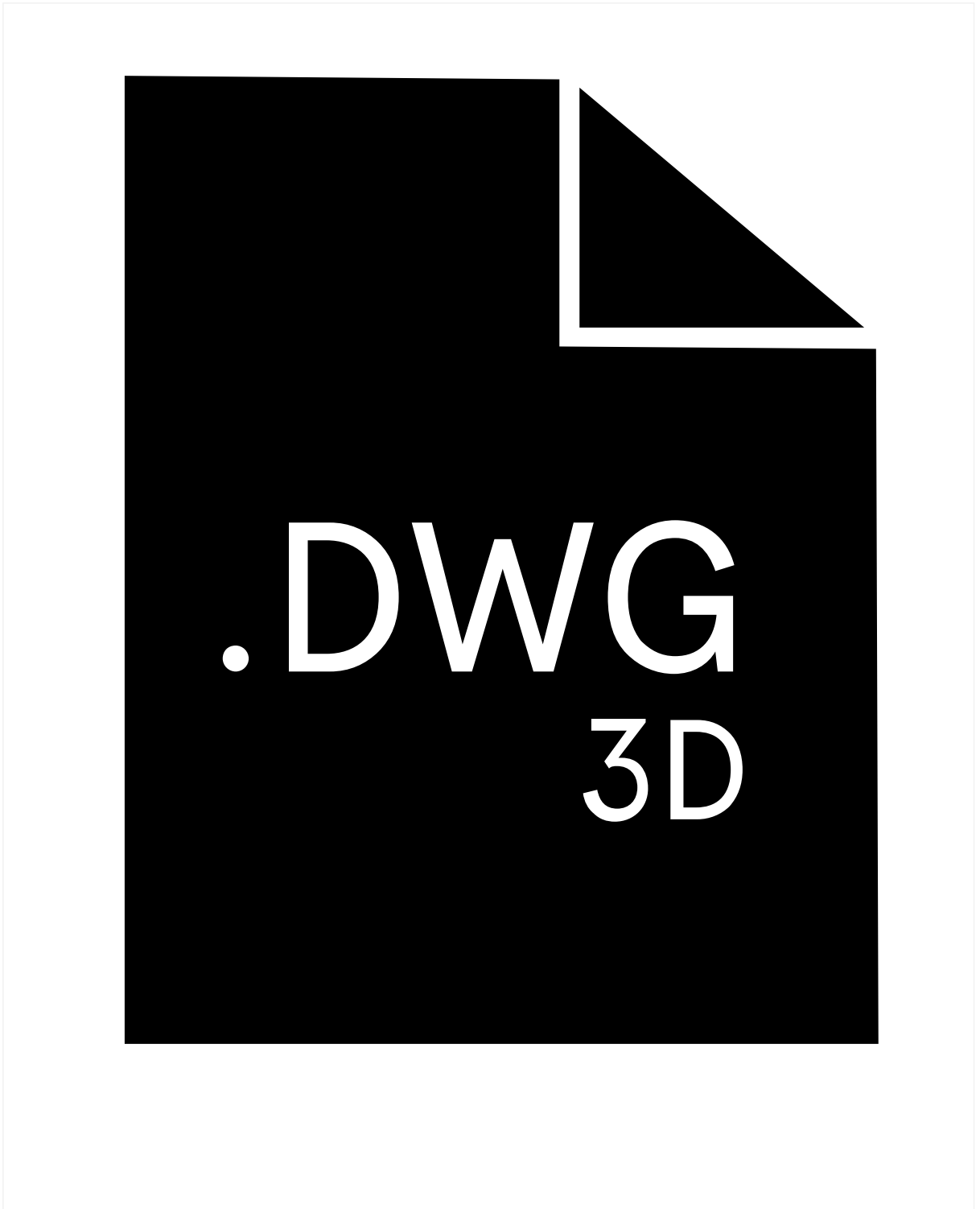

ophelis docks Bancs DWG 3D

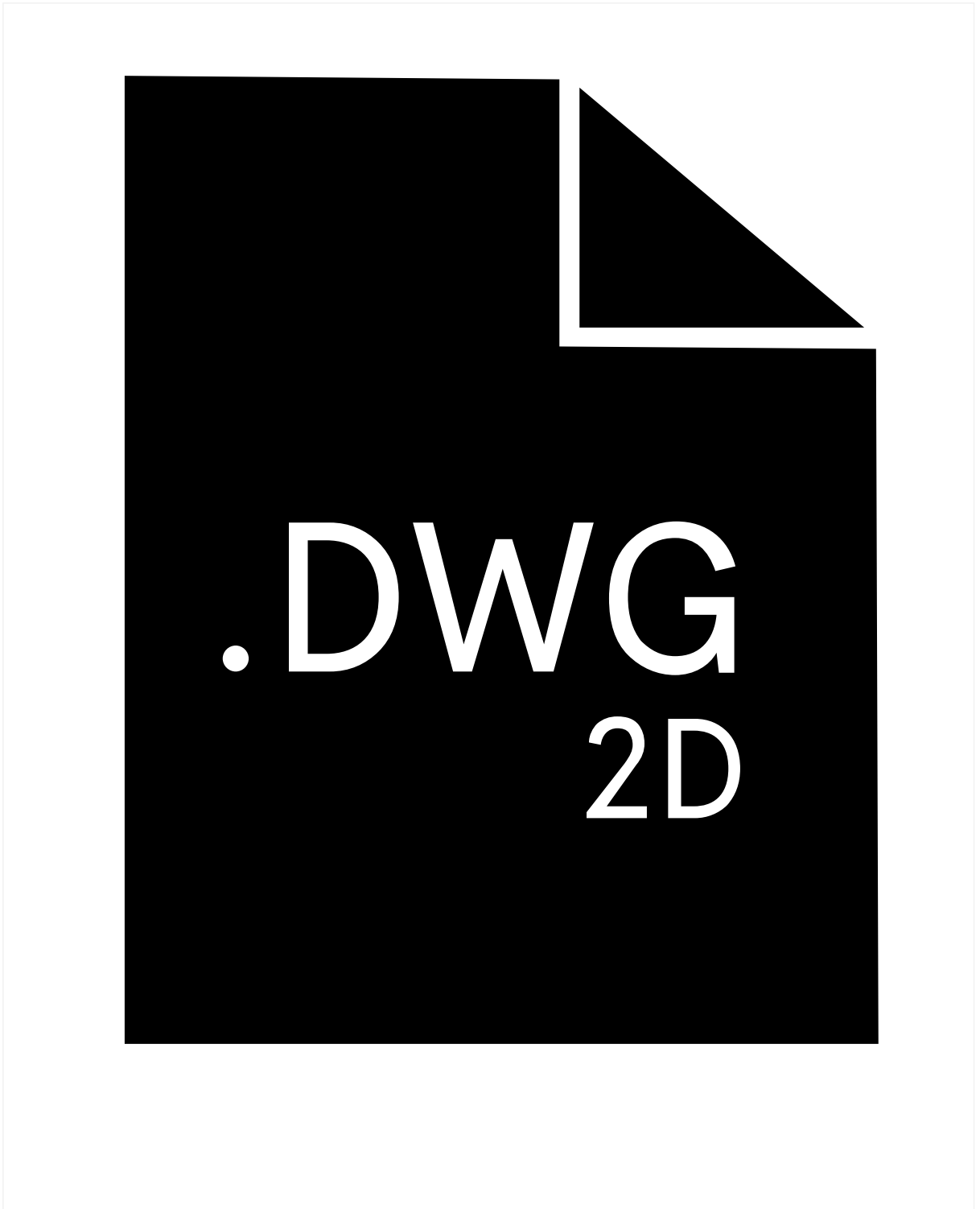

ophelis docks Bancs DWG 2D

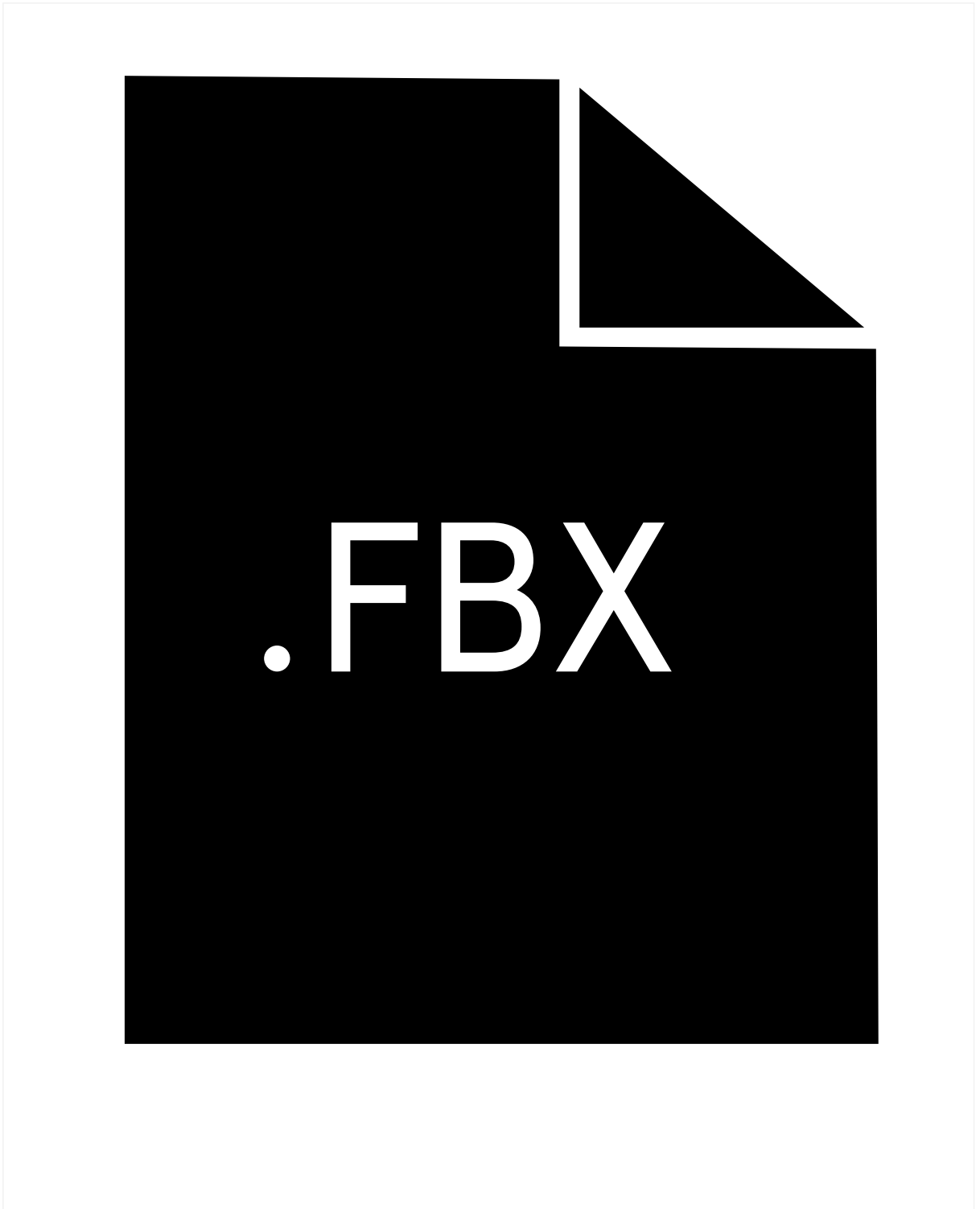

ophelis docks Bancs FBX

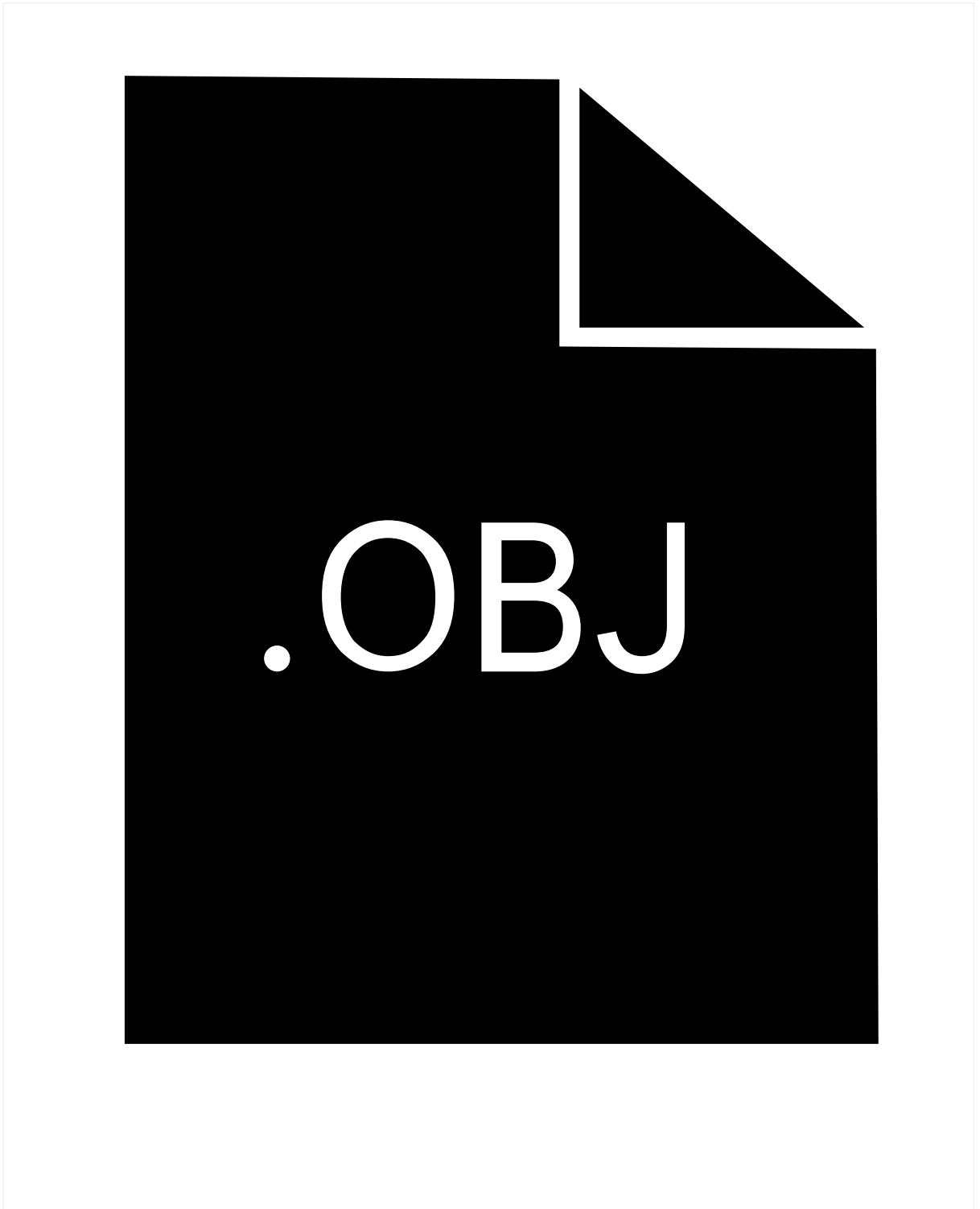

ophelis docks Bancs OBJ

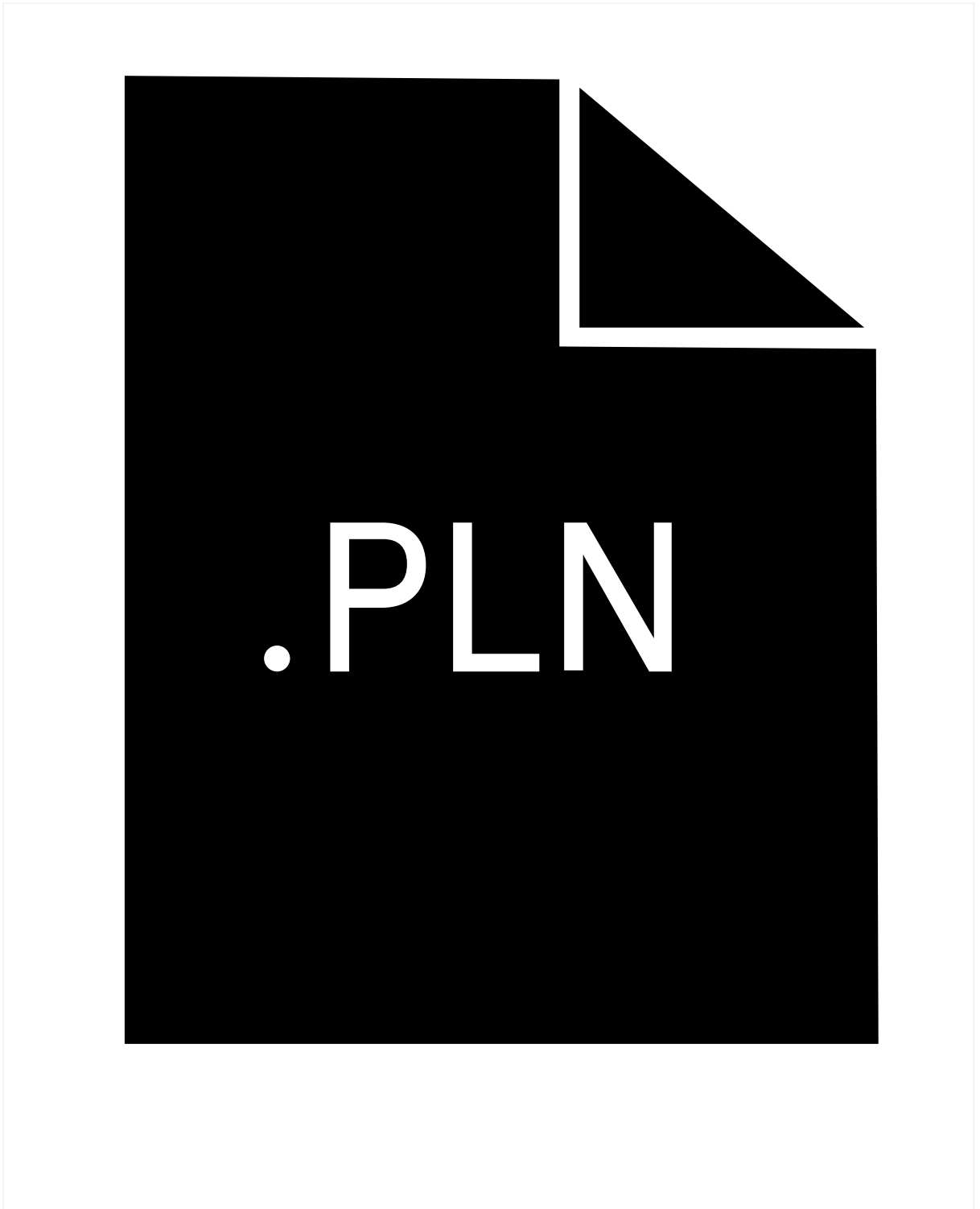

ophelis docks Bancs PLN

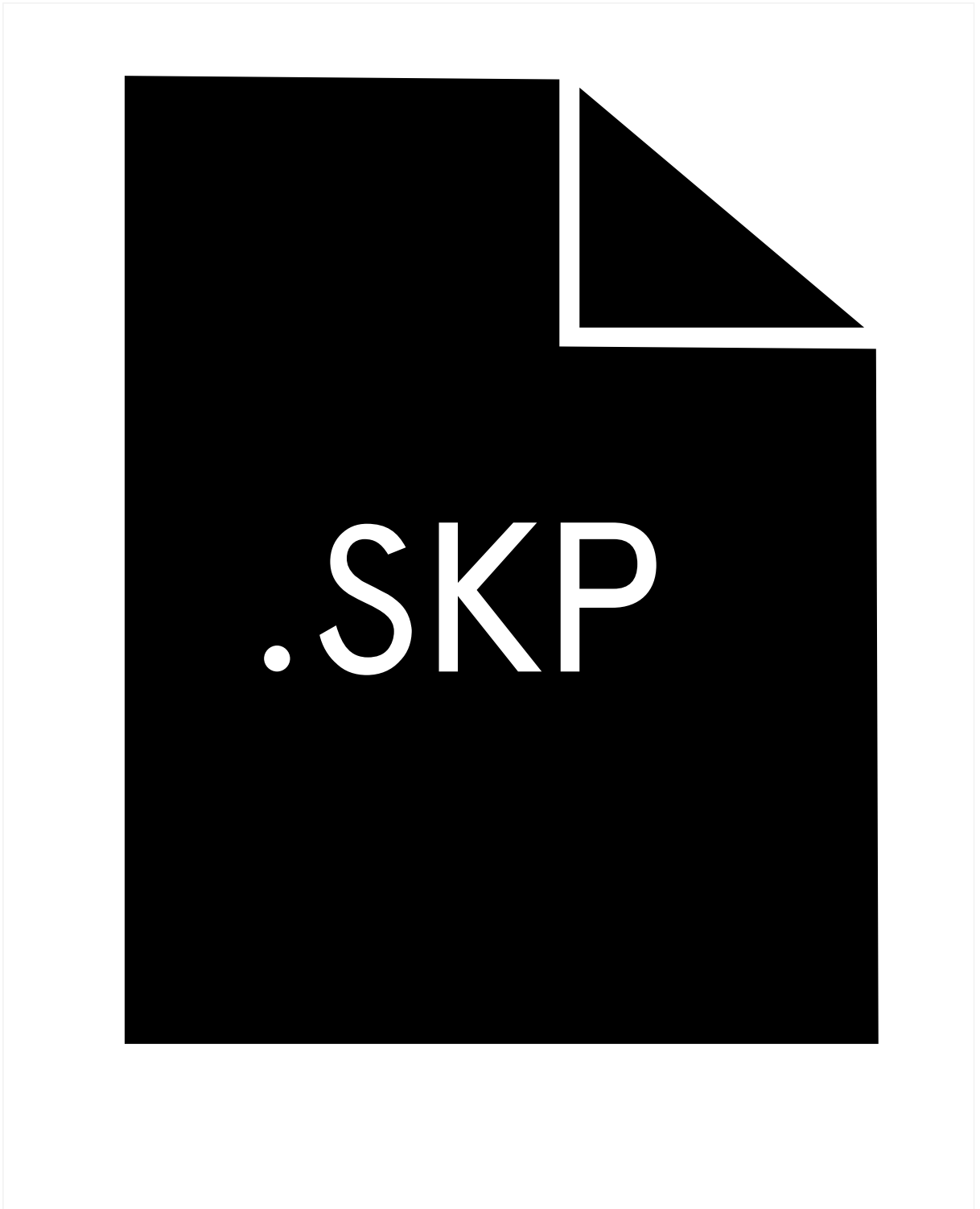

ophelis docks Bancs SKP

